

J600R Miniature Turbojet *Instruction Manual*

(Version 1.6/2007)



1111/1 Pattanakarn Road, Suanluang, Bangkok 10250, Thailand
Tel : Intl + 66 2318-6918: +66 2717-8645 Fax: Intl + 66 2318-6921
Website: <http://www.pstjets.com> : E-mail: pst@pstjets.com

© Copyright 2004-2007 PST Jets Co., Ltd. All Rights Reserved

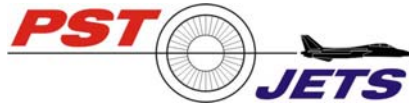

J600R Instruction Manual

Welcome Notes

Dear PST J600R owner,

Congratulations on the purchase of your new PST J600R miniature turbojet engine.

Let us greet you in our Thai tradition, "Sawasdee" which means welcome or greetings in Thai. We are committed to producing and delivering quality products to our customers. As avid Jet modelers we feel we have a good understanding of what other modelers look for and need in a turbine engine.

The J600R is the result of significant R&D and manufacturing development undertaken since 1997. In early 2003, we launched the J600R which is the successor to our original popular J600. The J600R incorporates a PST designed modified diffuser, combustion chamber, and tail cone resulting in higher thrust output. The engine controller unit, TEMS, is a state-of-the-art device which is specifically manufactured/programmed for the J600R. Your engine and support system have been factory tested and passed our rigorous quality control standards. The appearance of the bluish tinge on the exhaust cone is normal after factory testing of the engine prior to shipment. Factory test runs also serve as the "break-in" and seating of bearings and internal components procedure. All engines leave the factory with the confidence that they meet specifications for performance and reliability that our customers expect.

Safety is our credo. Regardless of your turbine experience, it is necessary to carefully read this manual in its entirety before attempting to operate the J600R. This manual has important information that will ensure safe operation of the J600R.

Please read it !

We are dedicated to customer satisfaction. Technical support is available thru email 7 days a week. Replacement parts are always in stock for prompt service ensuring quick turn-around time.

Thank you and enjoy.

PST Jets Co., Ltd.
1111/1 Pattanakarn Road
Suanluang, Bangkok 10250
Thailand

Web site: <http://www.pstjets.com>
Email: pst@pstjets.com
Tel : Intl + 662 318-6918
 Intl + 662 717-8645
Fax : Intl + 662 318-6921

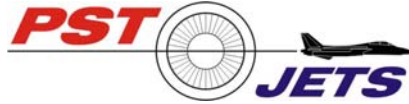

J600R Instruction Manual

Notices and Disclaimers

All contents copyright © PST JETS Co., Ltd., Bangkok, Thailand. All rights reserved.

No part of this manual may be reproduced, translated, transcribed or redistributed without written permission from PST JETS Co., Ltd. All product information and specifications are subject to change at any time without notice.

The “**PST JETS**” logo and “PST JETS with turbine wheel and passing jet” logo are trademarks of PST JETS Co., Ltd., Bangkok Thailand.

Disclaimer: The turbine engine is a sophisticated piece of machinery. Modeling experience, basic turbine knowledge, and technical common sense are required. Always seek expert advice or experienced turbine operators before operating the engine. If not operated properly, turbine engines are capable of causing property damage and/or bodily harm to both the operator and other persons in proximity. PST Jets assumes no liability for damage that may occur from the use/misuse of this product in any form whatsoever. We recommend that you visit GTBA and read about turbine safety and code of practice.

PST JETS assumes no responsibility for errors contained in this document and is not liable for any damages resulting from such errors. This manual is not controlled by revision. For latest version and updates, check our website www.pstjets.com or contact us at pst@pstjets.com

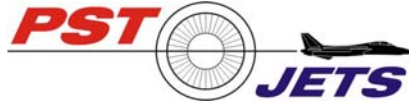

J600R Instruction Manual

Warranty

PST JETS Co., Ltd. is hereinafter referred to as "PST". The warranty period for the PST J600 and J600R is 1 year from the original date of purchase or 150 run cycles, whichever shall occur first. Warranty is valid for original owner only and non-transferable upon resale. The warranty includes parts and labor and is limited to manufacturing and material defects only. The limited warranty does not cover the electric starter motor, batteries, or glow plug. Upon replacement of components from a warranty claim, the replaced components and or engine servicing will be subject to the original warranty coverage period.

Shipping costs (including insurance and applicable duty and taxes) to the local PST representative or with authorization PST, for any warranty claim are the sole responsibility of the customer. Return shipping is covered by PST in the same method of receiving the shipment from the customer. Should any part of the product need to be returned from the PST representative to PST headquarters (Bangkok, Thailand), this shipment cost is covered by PST. Any additional costs are the responsibility of the customer. PST assumes no liabilities for damage to products during shipping.

This warranty is void if any one or more of the following conditions applies. Under such conditions PST assumes no liability for personal damages, third party damages, loss of models, or any other consequences arising from the purchase usage of operation of the J600/J600R engine.

- a. The serial number or identification information is defaced, modified, or removed.
- b. The product is used for purposes other than that of radio-controlled model airplanes without written authorization by PST.
- c. The product has been damaged from a crash or otherwise accidental event, ingestion of foreign materials, improper installation / configuration, improper storage or environmental exposure, and any acts of god.
- d. The product has been subject to any form of start-up or operation with any incorrect fuel, oil, or fuel/oil mixture ratio.
- e. Dirty or contaminated fuel is used.
- f. Unauthorized maintenance or modifications have been performed on any part(s) of the product.
- g. The product has been abused, incorrectly maintained, or neglected.
- h. The product has not followed the mandatory check-up procedure, whereby every PST J600 should be inspected by a certified PST service representative or PST after 150 starts.

Yearly inspection is highly recommended but not mandatory. Components required in the inspection / warranty claim include the complete turbine as purchased, TEMS, thermocouple, and fuel pump. Please contact your PST representatives or PST for further details.

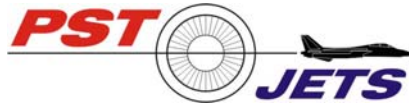

J600R Instruction Manual

Warranty (cont)

All turbines will be partially disassembled, inspected, and shipped within 5 business days of receiving. Damaged components that are deemed to be warranty covered are replaced, tested, and returned at PST cost.

For crash damaged, depending on the extent of damage, the turbine may require more than 5 days downtime, at which time the customer will be immediately contacted for a consultation. Please verify all service details with PST representative before shipping. Shipping cost and insurance is the sole responsibility of the customer in addition to the repair/service costs.

When upgrade option becomes available and the original owner wishes to have the engine upgraded, the newly installed components shall be given a 1-year warranty (valid from the return shipment date). Other original parts/components remain under the original warranty. Shipping cost and insurance is again the sole responsibility of the customer and is not covered under the modification costs.

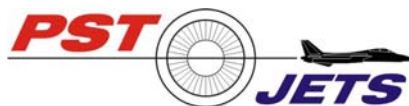

J600R Instruction Manual

PST Dealers/Representatives

USA/Canada

Dean Wichmann, HeliJet R/C International; dwichmann@shaw.ca; www.helijet.ca
Kelly Williams, HeliJet R/C International; kelly.williams@telus.net; www.helijet.ca

Australia/New Zealand

Kevin Dodd (TMAC), Brisbane, QLD - very experienced flight instructor and certified turbine inspector. Tel: 3207 9067 ; Mobile: 0411 645 637 ; E-mail: kdodd@bigpond.com
Phillip Collings, Brisbane - Service / Repair Center; E-mail: phylow@squirrel.com.au
Rene Redmond, New Zealand - Galtech Models Ltd.; Tel:063555747;Fax:063594501; E-mail: rene@galtechmodels.com; Website: www.galtechmodels.com

Europe

CalssicBirds Switzerland – Philippe Kraus

RC-Flight, Oslo Norway; Richard Blindheim: <http://www.rc-flight.com>

Japan

Masashi Tahara, Osaka, JetSet; Email: mars@ma.kcom.ne.jp ; ma@jetsetj.com ; www.jetsetj.com

South Africa

Bruce Rattray, GB Hobby Electronics
Website: <http://www.gbhobby.com>; Email: Bruce_Rattray@mondi.co.za

South Korea

JY Shim, Email: jyshim@inSCALL.com

Taiwan

Anton Lin, RC ARF.com; Email: skymaste@seed.net.tw

United Kingdom/Europe

Iain Nicol, Scotland - I.A.D. Model Designs, Tel +44(0)1236423448; Home of "Serpent"
Email: iain@iadmodeldesigns.co.uk ; Website: www.iadmodeldesigns.co.uk/home.htm

Martin Forrest, England –

Email: martinforrest@lineone.net ; martinforrest@telco4u.com

U.A.E

Kajoor Power Models, Dubai – Website: www.kajoorpower.com

** For more updated information, please visit our website at www.pstjets.com **

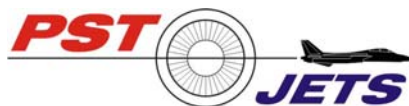

J600R Instruction Manual

Table of Contents

Welcome Notes	i
Legal & Disclaimer	ii
Warranty	iii
PST Dealers/Representatives	v
Table of Contents	vi
Introduction to turbine	1
Packing Lists	3
Safety Tips and Notes	4
Fuel System	
A. Fuel Tanks	6
B. Fuel Pump	7
C. Fuel & Oil	7
Gas System	
A. Internal Gas Canister	8
B. External Gas Tank	9
C. One-way Valve	9
D. Quick Disconnect Valve	9
Accessories	
A. Battery	10
B. Fuel & Gas Filters	10
C. Glow Plug	10
D. Chargers	11
E. Battery Checker	11
PST TEMS -Turbine Engine Management System	
A. System Components	12
B. Features of TEMS	13
C. Software Version	13
D. Installation of TEMS	13
E. GDT (Ground Display Terminal)	15
F. Programming Features	16
G. GDT Diagnostics Display Interpretation	18
H. TEMS Trouble Shooting	19
I. Auto Start Sequences	20
J. Calibrating MIN and MAX rpm	21

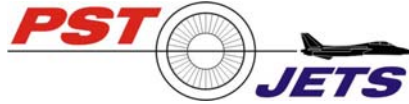

J600R Instruction Manual

Table of Contents (cont)

Mounting & Installation	22
Before Start	23
Starting	24
Maintenance	25
J600R Trouble Shooting	26
J600R Specifications	28
Diagrams	
A. Fuel & Gas Canister/Cartridge Setup	29
B. Internal Gas Canister/Cartridge	29
C. Main & Header Tanks Setup	30
D. J600R Sectional View & Parts list	31
FAQ	33
J600R Log Sheet	35

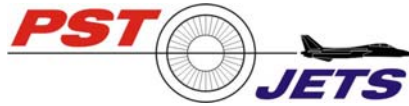

J600R Instruction Manual

Introduction to turbines



The first phase of turbine operation is intake and compression. In large-scale jet engines, the compression phase may involve several stages of axial and radial compression. For simplicity only a single centrifugal (radial) stage will be discussed in this manual. Axial compression is rarely seen in model turbines and is more reliant on having a clean air intake, similar to a ducted fan configuration. Centrifugal compressors rely far less on ram air effects, clean intakes, and Reynolds number effects, making them much more predictable at speed and much more suitable for use in model jets. After the air leaves the radial compressor, it flows outward through a set of primary and secondary diffuser vanes which harness the high velocity radial flow and transform it to high pressure axial flow into the pressure chamber. Diffuser design is critical due to the amount of losses induced in the transformation; the less energy lost in the compression process, the less energy needed to drive the compressor for the same overall mass flow and thrust output. Poorly designed diffusers can be susceptible to elevated temperature at the engine's front end and compressor surge / stall at different atmospheric situations. The turbine outer diameter size is also a contributing factor to the efficiency of the diffuser design. As the outside diameter increases, the airflow through the diffuser is smoother and has lower velocity gradients. Our PST J600R is an excellent example of a balancing act between performance vs. size and design complexity.

Next is the combustion phase. The combustion chamber is basically just a container that houses a continuous and very intense explosion. High temperature materials such as stainless steel Inconel and titanium are commonly used in large-scale turbines, but thin stainless steel / Inconel sheet is usually the more cost effective material of choice for models. The annular style chambers used in models have holes strategically located in the inner and outer walls for feeding the combustion flame and for cooling the exhaust gasses as they exit. Some holes are dimpled inward to produce higher velocity mixing jets. Fuel is added from the rear end of the chamber, sprayed forward through a number of vaporizer tubes that heat the fluid to produce a combustion ready air-fuel mixture. Combustion occurs in the front section of the chamber and only persists for a short distance rearward. After combustion, the optimized holes mix cool air (relatively cool...+100°C approx.) with the exhaust gasses to bring them down to a more suitable level in the exhaust turbine. (Absolute design maximum: 800° C in this case)

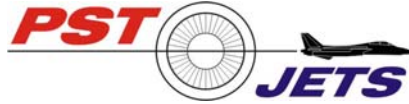

J600R Instruction Manual

Introduction to turbines (cont)

The turbine stage can also be radial or axial and involves multiple stages. For simplicity, a single stage is discussed here. As the exhaust exits the combustion chamber, it enters the nozzle guide vanes (NGV) which convert axial velocity to axial flow with a large radial component. The swirl induced in the NGV is optimized for interaction with the blade profile on the turbine wheel. The turbine wheel then harnesses a great deal of energy from the exhaust gas flow's radial component, leaving axial flow behind. The energy is transferred through the shaft and used to drive the compressor while the energy remaining in the exhaust flow after the turbine stage is converted directly into thrust. Miniature turbines today are equipped with hi tech ceramic bearing to support the shaft with the rotor assembly turning at more than 163,000 rpm. The J600R uses two angular contact, cageless ceramic bearings which are rated up to 220,000 rpm.

That's probably enough of an introduction on turbine theory. You bought this engine to fly. We have done most of the difficult parts of turbine design/building and have simplified operation procedures so that an average modeler can enjoy the world of jet flying. Fasten your seat belt...let's begin the exploration of the miniature turbine world and see what we have in stored for you.

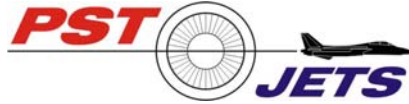

J600R Instruction Manual

Packing List

Please check that all components listed below were shipped with your J600R turbine. Contact your dealer or PST Jets if any items below are missing or appear to have been damaged during shipment. Our e-mail is pst@pstjets.com

SN600RAC – Auto start complete package:

- 1 PST J600R Turbojet Engine with electric starter
- 1 PST TEMS
- 1 GDT (Ground Display Terminal)
- 1 Fuel Pump
- 1 Gas solenoid valve
- 1 Fuel solenoid Valve (Optional)
- 1 Festo ball valve (Fuel Shutoff valve)
- 1 EGT probe
- 1 Glow plug (mounted on engine)
- 1 ECU switch with protective 15A Slow-Blow fuse
- 1 Battery pack (Ni-Cad 7.2V 1700SCR) *
- 1 Charging cable with battery male-connector
- 1 set of engine mounting brackets
- 1 set of quick disconnect fittings
- 1 set of 4mm gas/fuel tubing (tubing for fuel tanks installation is not included)
- 1 Gas Canister with 3-way connector and 1-way valve
- 1 PST Instruction Manuals CD-Rom

* Battery type and capacity may vary depending on supply.

Safety & Notes

IMPORTANT!!!

Safety: A model turbine engine is a highly sophisticated and potentially dangerous device if used improperly. Your turbine should be treated with care and the application of prudent safety standards. The following safety guidelines must be adhered to ensure your safety, the safety of others and your enjoyment of your engine.



- a. Always have a good fire extinguisher ready when starting turbine engines (Halon 1211 or BF2000 type recommended). Chemical fire extinguishers can be used but in this event the engine must be returned to PST Jets for cleaning and inspection.
- b. Always protect your eyes and ears during startup or when in close proximity to the starting of a turbine.
- c. Always start the turbine outdoors with good ventilation.
- d. Always handle Jet A1, Kerosene, and propane/butane gas in well-ventilated areas away from any open flame or heat sources. These substances are highly flammable.
- e. Do not stand in high risk areas of the turbine such as on the side and in the area of hot air behind it; and the immediate area in front of the compressor wheel. Again we emphasize never allow anyone to stand behind the turbine when it is started.
- f. Do not touch the engine while it is running. Turbines rotate at very high rpm and the engine casing can reach very high temperatures. Severe burns or body injuries can occur if you come into contact with the casing and/or exhaust nozzle.
- g. Do seek expert advice for installing the turbine and support system to the airframe.
- h. Abort start or any flight attempts if excessive vibration or abnormal noise is evident.
- i. Keep unauthorized persons, especially children, away from starting area. We recommend at least 30 feet away.

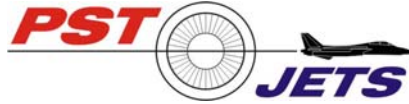

J600R Instruction Manual

Safety & Notes (cont)

Notes:

- a. The recommended and default settings programmed into the ECU should not be altered unless absolutely necessary. The engine has been tested and operates to its designed performance specifications under these parameters. We cannot guarantee proper operation of the J600R if the parameters are altered or different fuel pumps and accessories are used. E-mail us for technical help if you have any questions.
- b. Use good chargers to charge both ECU and Rx batteries. Limit the ECU battery (7.2V Nickel Cadmium with at least 1700mAh capacity) to two flights for one full charge. The fuel pump drains lots of current at high rpm and no flight should be made without recharging the ECU battery after approximately 25 minutes of engine run time.
- c. Make certain that all wiring and plumbing is done correctly in accordance with the information contained in this manual.
- d. Use filtered and moisture free Jet A1, Jet A, or kerosene fuel only.
- e. Use turbojet oil, we recommend Exxon 2380, Aero Shell 500, or Mobil Jet Oil II). **2-stroke oil is not allowed and will cause damage to the engine thus voiding the warranty.**
- f. Fuel/Oil mixture of 5% should be used (See Fuel section for more details).
- g. Extra fuel and gas filters are highly recommended to avoid clogging up of the "last chance filters" located inside the front cover. The Kavan filter as shown in this manual is a suitable filter type. Avoid cheap motorcycle or automobile plastic filters, they may be used in the refueling system but not in the main system.
- h. Bubble-elimination devices should be used in or as the header tanks for bubble-free fuel. Seek expert advice if you are not experienced.
- i. For manual or emergency shutdown, a fuel shut-off valve (Festo Ball Valve) is included and should be installed between header tank and turbine fuel inlet.
- j. LPG or camping gas with a maximum 70/30 Propane/Butane mix can be used. Use a one-way valve for filling the gas canister. High pressure propane/butane can freeze up the solenoid valve thus locking the valve in the closed position.
- k. The fitting valves and connectors supplied are of a very high quality although other similar products may be used.
- l. When new devices or accessories are adopted, it is wise to test them on the bench prior to installation into the airframe.
- m. Latest addition of Fuel solenoid valve helps to prevent inadvertent flooding of the engine during fueling in case that the manual shut off valve is left open. However, manual shut off valve is still the safest mean to stop the fuel flow.

Fuel System

A. Fuel Tanks

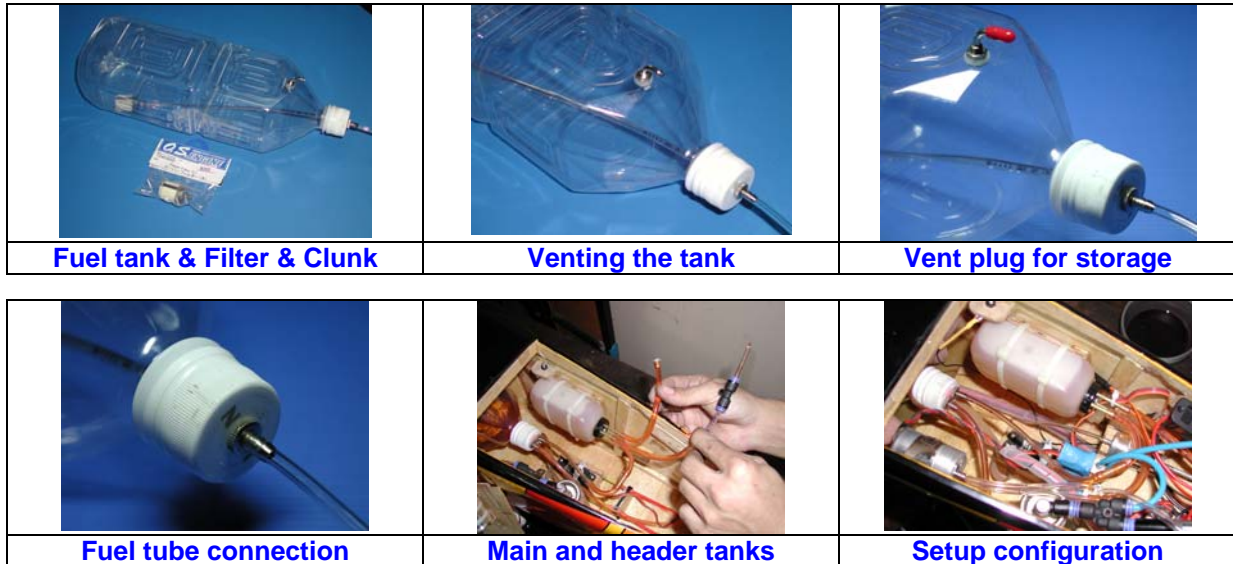

1. Use a sturdy polyurethane plastic bottle(s) or specially made Kevlar tank(s) with a total capacity of at least 1.5 liter (2 liters recommended). This may vary upwards depending on the requirements of your model including items such as size, weight, wing loading and flight time requirements.
2. Use bubble-free filtered clunks for header tanks. We recommend the OS Super Filter (size to suit tank size) as shown in the picture above. These filters are inexpensive and do the job well. Similar bubble-elimination device may be used as well.
3. Use the clear 4mm tubing provided for the fuel line. Silicone gasoline/benzene (Tygon) fuel line can also be used if preferred. If you want to connect Tygon fuel line with the 4mm fuel line, insert at least ½ " inch of the 4mm line into the Tygon line to ensure a leak free connection
4. Vent the fuel system to avoid the creation of a vacuum. See pictures above and diagram A. **Important: Make sure the vent line is large enough, as insufficient venting will cause a vacuum overcoming the fuel pump suction capability resulting in flameout or the breakage of your fuel tank.**
5. During startup we recommend that you run fuel lines from the main tank vent to an external fuel tank outside of the airframe. The external fuel tank can serve as an overflow and a ground start / supplementary fuel source. The airframe vent tube should be at least ¾" in length and cut 45 deg facing forward to avoid boundary air effects. This takes up any fuel that flows out during filling, it also reduces consumption of onboard fuel during startup which in turn allows you longer flight times.
6. If multiple tanks are used, make sure that the tanks are of same size/shape and fuel lines connecting the tanks are of equal length and that vent line is provided. See diagram C for more details. Seek experienced or expert help if you are uncertain.

Fuel System (cont)

7. Fueling is accomplished through the header tank into the main tank. Make sure that air bubbles are removed from the header tank. Air inside the fuel line will cause a flameout. Do not use flex tube or a clunk inside the header tank. The feed line should be geometrically centered in the header tank. See diagram C for more detail.
8. After the header tank is filled you can then fuel directly into the main tank for faster fueling. Your tanking system must be fitted with a fill tube to the main tank.
9. Ensure that you have safely wired and joined all line connections to prevent them from coming loose during operation.

B. Fuel Pump



1. Observe the pump fueling direction. Fuel goes in on the side marked by a small indentation and out on the other side.
2. Use the clear 4mm tubing provided for fuel line connections.
3. Install ball valve between header tank and engine, either between the header tank and the pump (on suction side), or between the pump and engine (on pressure side).
4. Use a good gasoline filter between the fuel pump and the engine. It is better to have the filter behind the pump to avoid bubbles caused by suction/cavitations.
5. Ensure that all wires and line connections are properly joined and attached to prevent them from coming loose during operation.

C. Fuel and Oil



1. Use Jet A, Jet A1, or kerosene. Make sure that the fuel is clean and free from moisture and other forms of contamination. Water is heavier than fuel and will settle at the bottom of the container.

Fuel System (cont)

2. The fuel tank must be free from foreign particles.
3. Use good quality turbo oil such as those in the picture above. **2-stroke oil will cause serious damage to the engine and void your warranty.**
4. The fuel must be mixed with 5 percent turbo oil. For simplicity, mix five parts of oil to 100 parts of kerosene. The J600 will tolerate mixture imperfections between 4-6%. Too little oil will shorten the bearings life due to higher temperature. Too much oil will reduce the engines performance due to unnecessary stress on the bearings.
5. We recommend that the fuel be mixed in gallon scales, as the mixing will be more accurate. Example: mix 1 quart of oil to 5 gallons (19 liters) of kerosene. Most turbo oil comes in quart cans, so mixing with 5 gallons of kerosene is simple.

Gas System

A. Internal Gas Canister



1. A custom machined internal gas canister is provided with a quick connector attached.
2. Use the blue 4mm tubing provided for gas connections.
3. The two-way quick connect is connected to the gas solenoid valve and the one-way valve.
4. The direction of the one-way valve is marked on the valve itself. "IN" direction is from the end with silver tape. The valve must be connected with the "IN" direction facing away from the canister to allow proper filling. In the pictures above the "IN" direction is plugged with an orange stopper.
5. The tube ends should be pushed all the way into the connector/valve to avoid leakage.
6. Fill the canister by connecting an external gas source (Propane/butane 70/30 mix) to the one-way valve "IN" direction. Point the external gas-filling tank (GAS CAN) down to let the liquid flow into the canister.
7. Stop filling when the canister is 1/4 to 1/2 full. Since there is no visual indication, just approximate the filling amount. Very little is actually required for one successful auto start. The canister supplied is larger than required. From our tests, we can obtain more than 5 starts with one fill (3 starts with a new gas cartridge).
8. Disconnect the filling line carefully, as high pressure propane is present in the line and will be forced out briefly. **Safety: Use towels or rags to cover the valve and keep your face and eyes away during disconnection. Do not smoke any where near your turbine at any time.**

Gas System (Cont)

9. Make sure that the canister/cartridge stands upright in the airframe to avoid liquid gas entering the engine. During start, excessive flame and engine surge will result if the liquid gas is allowed to enter the engine. (This is known as a hot start) This is not healthy for the combustion chamber or your model.
10. **For safety purposes, the onboard gas canister/cartridge should be emptied after flying sessions prior to storage. Simply disconnect the line to the solenoid valve or the one-way valve. Safety: Use towels or rags to cover the valve and keep your face and eyes protected during the disconnection.**

B. External Gas Tank



1. External gas tanks may be used to replace the internal canister/cartridge.
2. Use a similar manual valve connection as shown in the picture above (the valve is not included but available as an option from PST).
3. Connect the external gas line to the solenoid valve via a quick disconnect connector.
4. Do not by-pass the gas solenoid valve during start. **Incorrect manual metering of the gas may cause internal damage and flame coming out of tail cone.**
5. Before start, open the external gas tank valve.
6. After start, close the valve and disconnect the external gas tank. **Take care that the disconnection is done far from the exhaust cone as there could be excess gas escaping during disconnection. Remember that this gas is highly flammable.**

C. One-way Valve



One-way valve "IN" direction is from the silver shaded side. Use this valve for filling the gas canister.

D. Quick Disconnect Connector



This can be used for both kerosene and gas. It allows easy connection and disconnection of tubing extension.

Accessories

A. Battery



1. Use a good 6-cells 7.2V Ni-Cad or 7.4V Lithium Polymer battery pack for the ECU
2. Use at least 1700mAh capacity battery
3. The supplied battery pack is Sanyo 1700SCR mAh

B. Fuel & Gas Filters

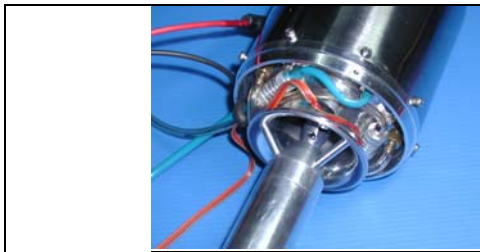

Gas and Kerosene “last chance” filters are already fitted inside the front cover



Extra protection is recommended with additional external filters

C. Glow Plug



Glow Plug & Needle



Pull Out the coil

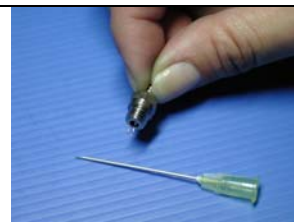

Coil pulled out 2mm



Glow Plug Cap

1. Use an OS glow plug or similar threaded plug. Higher resistance or colder glow plugs may require higher glow voltage and this is programmable via the GDT. (see TEMS section)
2. The coil needs to be pulled out. We recommend using a needle for this job. Be careful when pulling out the coil so as not to break the filament. For a new glow plug, heating the filament prior to pulling out the coil will greatly reduce the chance of breakage.
3. The coil must be pulled out about 2mm.
4. Replace the glow plug carefully and tighten firmly. Just firmly, do not over tighten.
5. The red glow plug cap goes over the plug. Pull the red spring-loaded wire and place the cap over the glow plug, then release to engage the glow plug head.
6. Make sure that the cap fits firmly and will not come loose during operation. Tie down the wiring to prevent any possibility of the cap entering the turbine if it inadvertently comes loose.

Accessories (Cont)

D. Chargers

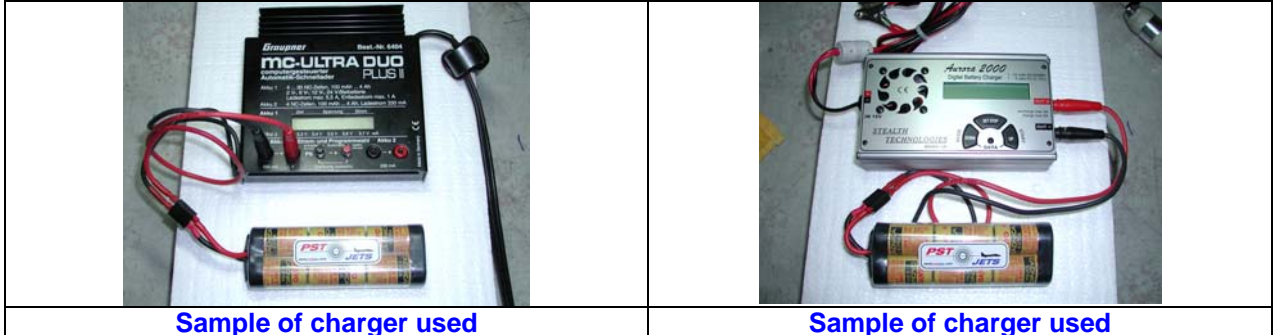

1. Use a high quality Ni-Cad/Li-Polymer charger that has good charging, discharging, and conditioning cycle features. The supplied Ni-Cad battery can be quick or slow charged.
2. Automatic charging is highly recommended.
3. Connect the appropriate charger connectors to the supplied charging cable taking care that the polarity is correct.

E. Battery Checker

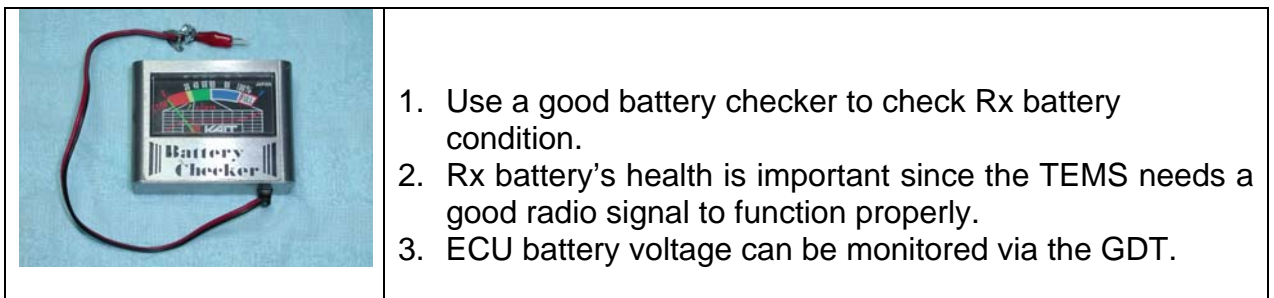

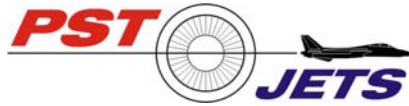

J600R Instruction Manual

PST TEMS - Turbine Engine Management System

The PST TEMS is a highly sophisticated electronic turbine controller that is simple to operate. It incorporates coding and circuitry designed and written specifically for the J600R. Your J600R will perform at optimum levels under the control of the PST TEMS. Do not, under any circumstances, attempt to use the J600R with an ECU system other than the one provided. Such operations can cause the turbine to operate outside its proper parameters which is dangerous and will void the warranty.

A. System Components



Your system consists of the following:

1. GDT (Ground Display Terminal) – handheld terminal for programming, operating, and monitoring the TEMS.
2. TEMS – engine controller unit which gather data from connected sensors and manipulate them for optimum commanded performance.
3. Fuel Pump – supply pressured fuel to the engine as directed by the TEMS.
4. Gas Solenoid Valve (SMC) – automatically turn on and off starting gas as directed by the TEMS during auto start sequence.
5. Internal Gas Canister – self-contained remote starting gas.
6. Fuel Shutoff (Ball) Valve – manually shut down the engine and provide fuel cutoff to the engine during fueling.
7. EGT Probe – K-type temperature sensor
8. Hall Effect Speed Sensor – located in the engine front cover to pick up revolution information.
9. Battery – main power for the TEMS and electric starter, 7.2V, 6-cells, 1700-1900mAh Ni-Cad (Current supply - Sanyo 1700SCR)
10. ECU Power Switch with 15A Slow Blow fuse in case.
11. Optional: Fuel Solenoid Valve

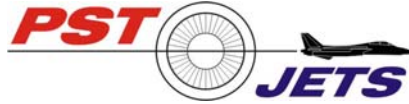

J600R Instruction Manual

PST TEMS (Cont)

B. Feature of the TEMS

The TEMS is designed to monitor various parameters of the J600R. It has full auto-start capability when coupled with the electric starter and fuel/gas solenoid valves. The parameters monitored while the turbine is running are: Turbine speed (RPM), Exhaust Gas Temperature (EGT), battery voltage, pump voltage, and radio signal validity. F/Safe Time to shutdown the engine can be set to 1, 1.5, or 2 seconds.

C. Software Version



As of September 2006, the latest software version is V2.38 for the TEMS and V2.25u for the GDT. Added features are Fuel solenoid function, Glitch Counter, and Adjust F/Safe Time which will be discussed in more detail later. Please email us or monitor our website for upgrades availability.

D. Installation of the TEMS: Important

1. The TEMS and radio receiver must be placed as far away from each other as possible.
2. The TEMS battery pack and the R/C receiver battery pack should be placed as far away from each other as possible. This is to eliminate the chances of R/F cross talk or spurious signal induction between the units which may affect the operation of your radio equipment. However, this is only a precautionary measure as there are many jets flying with both battery packs bundled together. Range check before flight is the safest practice.
3. Your J600R uses a Hall Effect sensor rather than an optical sensor to measure rpm. This obviates the problems associated with traditional optical sensors such as light blanking from the sun in external mounting situations. Avoid placing servos, solenoid valves, pumps, or magnetic objects inline with the engine front cover to minimize the chances of interference to the Hall Effect rpm sensor.
4. When plugging the TEMS into the receiver, extreme care must be taken with the polarity of the receiver. The TEMS has JR type connectors. This will plug into Futaba and other "positive middle" type radios but care must be taken not to reverse the polarity. Other "middle negative" systems may be used but the polarity of the TEMS plug will need to be changed. Pay careful attention to the system you are using.

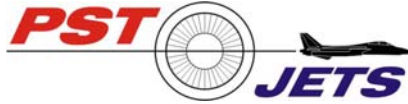

J600R Instruction Manual

PST TEMS (Cont)

5. Extreme care must be taken not to reverse the polarity of the battery to the TEMS. Incorrect polarity can destroy the TEMS and will not be covered by the warranty.
6. TEMS is protected by 15-amp slow blow fuse and must only be replaced with the same rated fuse.
7. Use the supplied fuel pump only. The use of any other fuel pump without factory approval will void your warranty.

Wiring of the TEMS to the radio and accessories is quite simple and straight forward. The wires are marked where they exit the TEMS. Male connectors to Fuel Pump and Glow Plug are color coded **blue** and **green** to avoid incorrect connection.



Battery – Black-Negative ; **Red-Positive**

Pump – **Blue-Negative** ; **Red-Positive**

Glow – Black-Negative (engine case) ; **Green-Positive** (glow plug head)

Starter – Black-Negative ; **Red-Positive**

GDT – Remote connector for Ground Display Terminal

EGT – For connection to Temperature Probe sensor

Revs/RC – Three-wires cable: Revs (RPM sensor) plug is the male pins and the R/C plug is standard JR servo plug which connect to Rx throttle channel

GAS – not labeled here but it has a distinctive connector (blue color) that will connect to the solenoid valve (two-wire cable)

FUEL – not labeled here but it has a JR male pin connector similar to the Revs cable but with a distinctive wire color



PST TEMS (Cont)

E. GDT (Ground Display Terminal)



The PST GDT has three control press-in buttons. The UP and DOWN buttons are used to scroll between menu pages and to set programming values. The ENTER button is used for selecting the menu page feature and to store the input values into the TEMS unit. When you first turn on the system, the software version page will be displayed momentarily then it will switch to the first default screen. By pressing UP, the menu will change thru the main menu pages each time the key is pressed. Sub-menus can be accessed thru the ENTER key, the UP and DOWN is then use to scroll thru the sub-menu pages. Menu Pages are in the following sequence:

Start Up First screen

Start Enable

Show Shutdown Data

Prime Pump

Ramping Values - Ramp Switch – Lo

- Ramp Switch – Hi

- Ramp Up – Lo

- Ramp Down – Lo

- Ramp Up – Mid

- Ramp Down – Mid

- Ramp Up – Hi

- Ramp Down – Hi

Physical Adjusts - View Runtime & Start

- Adjust Glow Driver

- Learn R/C Parameters

- Adjust Start Ramp

- Adjust Idle Revs

- Adjust Max Revs

- Glitch Counter

- Adjust F/Safe Time

- Reset To Default

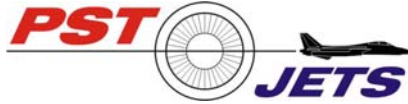

J600R Instruction Manual

PST TEMS (Cont)

F. Programming Features

Start Enable - Press UP until you see this page displayed. This page is used for initiating the auto start from the GDT. Press UP to start the turbine. Another option for starting the turbine is from the transmitter. Cycle the throttle and trim to minimum, then place trim to max. Move the throttle stick to max and then back to min. The start sequence should initiate if the stick/trim movement are done within 5 seconds. More details of startup are in the Auto Start section.

Show Shutdown Data - Press UP until you see this page displayed. Press ENTER to select the page. The page is a freeze frame of the turbine condition at the point of shutdown. The displayed values are showing what the TEMS was reading at the time of shutdown. You can see what caused the shutdown, and also what the other readings were at the time. "*" is displayed beside the cause of shutdown. (see the GDT Diagnostics Display Interpretation section for details). The data will be retained even if the TEMS is switched off and on again until the next shutdown. To exit back to the main menu, press UP or wait for ten seconds.

Prime Pump Feature - To ensure a successful auto start, the pump and fuel lines should have fuel in them right up to the engine inlet. This is achieved by running the pump to fill the lines. **Caution:** Do not over prime the engine as this can cause a hot start. After the first setup of the system, the fuel pump may be dry and before priming, the pump needs to be fed with a small initial amount of fuel. Use pressure to initiate the flow of fuel to the pump before priming. It is advisable to disconnect the delivery line to the turbine and redirect it to an external fuel container. Run the pump a few seconds to circulate fuel in the system then reconnect the fuel line.

Press UP until you see this page displayed. Press ENTER to select the function. Pressing the UP button will start the pump running at idle. To stop the pump, press UP again. The display will return to the menu page automatically. To perform the priming function again, repeat the sequence.

Setting of Ramping Values - This option is open to the user but the default parameters are recommended. Use the values as set from factory as shown on data sheet at the end of this manual. The numbers can be simply interpreted as time (fraction of second) required for ramping. The higher the number, the longer it takes to ramp thus slower ramping. This feature is useful for fine tuning the J600 at different atmospheric conditions.

Physical Adjusts - Press UP until you see this page displayed. Press ENTER to access the sub-menus below:

- **View Runtime & Start** - From this menu, press ENTER to display the turbine runtime and number of starts. These values can only be reset by factory representatives after engine service.

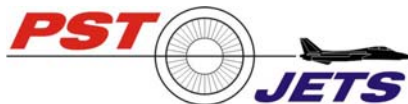

J600R Instruction Manual

PST TEMS (Cont)

- **Adjust Glow Driver** - Press ENTER from this menu to activate glow plug voltage setting. The default value is set at 180 meaning 1.80V. Use UP or DOWN to adjust the value to the desired level. Different glow plugs with higher resistance will require a higher voltage to sustain the glow plug heat during start. Range can be from 180 to as high as 270.
- **Learn R/C Parameters** - This allows the TEMS to memorize and store your radio's throttle settings for Shutdown, Idle, and Full thrust positions. This has to be done only once unless the radio is worked on or replaced.

JR: Throttle ATV (Travel Adjust): -100/+100; Throttle Trim Rate: 50%; Normal
(On PCM 10X, remove all MIX and SLOW functions on throttle channel)

Futaba: Throttle ATV: -100/+100; Reversed

On Futaba FF8, 8UAPS, 9ZAP, etc. with digital trim the following is recommended:
Set the "Throttle cut" to 40% and assign to switch "E". Trim to be set at midpoint. With switch toward you, is "trim min"; switch in mid position is "trim max". To shut motor down, with stick at min, move the switch E to the "trim min" position.

First switch the radio and receiver on, set the throttle trim and stick positions to minimum. Press UP until the "Physical Adjusts" menu displays, then press ENTER and UP button until "Learn R/C Parameters" menu displays. Press ENTER and follow the instructions displayed on the screen. Once finished, the information is saved into the TEMS.

- **Adjust Start Ramp** - This is the ramping from zero to idle point. Default value is 65. The higher the number is set, the longer the ramping time. It is not recommended to go below 45. You may increase this value as the fuel pump becomes freer (broken in) flowing to avoid flame during start. This value can go as high as 100 for a strong pump.
- **Adjust Idle Revs** - Use this function to increase the default idle value above 55,000 rpm.
- **Adjust Max Revs** - Use this function to derate the engine. Maximum rpm is 163,000.
- **Glitch Counter** - The glitch counter will count once every time the TEMS detects a "failsafe size" pulse that is set in the radio, which will be below the normal shutdown size. If the radio system restores to normal before this time has elapsed, normal operation will continue, and the counter will record one glitch. The counter is valid only for each flight and will reset on "start" command. The counter will not save glitch counts once the engine has been shutdown so even if glitches are picked up while in the pit area after shutdown and they are shown in the counter, these will not be saved to the "glitch memory" for that flight. To be sure you view the in flight glitches only, power down and power up and go into the glitch counter display.

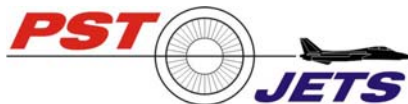

J600R Instruction Manual

PST TEMS (Cont)

- **Adjust F/Safe Time** - This function is used to set time delay before the TEMS shutdown the turbine once fail safe condition is detected. Adjustable time delay can be set at 1 sec, 1.5 sec, or 2 sec. This would mean that if the receiver went into fail safe condition and recovered within the set F/Safe Time, the turbine will not shutdown. However, if the fail safe condition lasted longer than the set F/Safe Time, the turbine will be shutdown. Fail safe mode is a special radio function (usually with PCM receiver), so please check that your radio has this feature. Recommended setting procedure is discussed in the "Before Start" section.

- **Reset to Default** - Use this page to reprogram the TEMS to default value settings.

G. GDT Diagnostics Display Interpretation

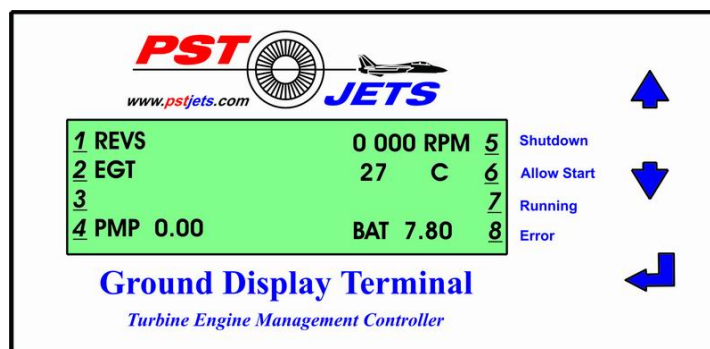

The number 1-8 is not part of the display but they are shown for clarity in the same position where the * symbol appears on screen and their meanings are shown below.

Prior to and during start:

- 1** Revs are below allowable start RPM.
- 2** EGT is below allowable start EGT.
- 3** Not used.
- 4** Throttle stick is not at stick min and trim is not at max position.
- 5** TEMS is in shutdown mode – No start is possible.
- 6** R/C signal and conditions are ok to allow start. Only active after "Start Enable" has been pressed or throttle stick/trim cycled as described earlier.
- 7** Once this comes on, the pump will start ramping and the turbine is considered running.
- 8** If on, indicates an error in the TEMS software. The user is warned that the unit should be re-programmed by a PST Jets authorized service center, even if all appears to be working correctly. The TEMS will not allow a start and message "**Start Not Ready**" will be displayed. If flashing this indicates a fault while reading values from the processor chip. **** CHECK ALL VALUES AND VERIFY AGAINST THE DEFAULT VALUES ****

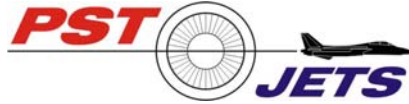

J600R Instruction Manual

PST TEMS (Cont)

While running:

- 1** Flashing indicates the turbine is exceeding Min or Max RPM and the TEMS is holding the pump to keep rpm within limits.
- 2** Flashing indicates the turbine is exceeding Max EGT and the TEMS is holding the pump to keep the EGT within limits.
- 3** The RPM signals has dropped out and the TEMS is filtering the reading to allow the RPM signal to restore itself.
- 4** Not used while running, except to indicate, at shutdown, if the user shut the turbine down.

After Shutdown:

- 1** Shutdown caused by revolution level going out of parameter, check for more details at "Show Shutdown Data".
- 2** Shutdown caused by EGT, check for more details at "Show Shutdown Data".
- 3** Not used.
- 4** Shutdown caused by user shutting down or R/C Invalid due to radio signal loss or radio fail safe condition exceeding the set F/Safe Time delay.
- 5** Indicates the TEMS is in shutdown mode
- 6** Same as during start
- 7** Same as during start
- 8** Same as during start

H. TEMS Trouble Shooting

After plugging in the GDT, please make sure that the following messages are **not** displayed. The message indicates some type of fault with the installation.

Messages:

"No Comms" – There is a communication error between the GDT and the TEMS. In this case, try switching off the power to the TEMS for 5 seconds and then switch on again. If this persists, contact us or PST service center.

"No R/C" – Your radio is not on

"R/C Rev" – Throttle channel is reversed. Change the direction of your throttle channel and repeat the "Learn R/C Parameters".

"R/C Invalid" – The R/C signal is not within the specification of the TEMS. Probable causes are radio signal loss or radio receiver is in fail safe condition. Try resetting the TEMS and check your radio system. Perform "Learn R/C Parameters" again. If this persists, contact us or PST service center.

"Glow Fail" – The glow plug filament is broken or the wiring to the plug is open. Check the wiring and replace the glow plug as described in previous section.

"Start Not Ready" – CPU error or if R/C is off or any other condition not healthy for start. In this case, try switching off the power to the TEMS for 5 seconds and then switch on again. If this persists, contact us or PST service center.

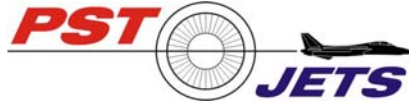

J600R Instruction Manual

PST TEMS (Cont)

Additional indications can be observed if there are other faults with the setup.

1. Pump starts running and then shuts down on "Pmp" – Flat battery pack or radiated interference between TEMS and receiver. First check your battery charge level this is the most common problem. If the battery level is good, move TEMS and receiver away from each other. Move TEMS battery and the receiver battery away from each other.
2. Pump will not increment or decrement while adjusting idle and full speed – Check that the throttle stick is at minimum while decreasing idle and at full throttle position while increasing rpm.
3. TEMS "hangs up" while setting radio limits – This happens if you try to set the radio throttle settings and the receiver is off or somehow the TEMS is not seeing the R/C signal. Switch TEMS off and on again and switch R/C on and do the settings again.
4. Pump surging – Check for proper ventilation and try circulating fuel in the pump motor for about 10-15 minutes.
5. Idle rpm drops below 55K – If the idle rpm swings down too much and sometimes causes flameout at idle, idle revolution needs to be increased thru Adjust Idle Revs function. Raise the idle to 57-60K. Differentiation between Idle thrust (residual thrust) at 55K and 60K is almost negligible.
6. No throttle response between 0-25% throttle (JR) – Set throttle trim rate to 50%.

I. Auto Start Sequences

This is how your TEMS system works. The TEMS will start and ramp the turbine up to idle speed then release the control over to the transmitter. The basic description of the auto start sequence and shutdown is as follows.

1. Turbine spins momentarily to 7,000 rpm to verify the battery and starter motor capability. Note: If the turbine does not reach 7,000 rpm within 10 seconds, the TEMS will abort the start and report "**Step Fail**" on the GDT.
2. Turbine is allowed to spool down while opening the gas feed and switching the glow driver on.
3. At 2,000 rpm, the turbine spools back up to 7,000 rpm and then allowed to spool down again.
4. At 2,000 rpm, the turbine spools back up to 7,000 rpm.
5. When the gas ignites, the glow circuit will be switched off and the starter motor will be re-engaged. Note: If no ignition takes place after 4 attempts, the start will be aborted and the TEMS will report "**Start Fail**" on the GDT. To restart, just reset the TEMS and repeat the auto start cycle.
6. When 7,000 rpm is reached and EGT is above 110 C, the pump will start.
7. At 30,000 rpm, the starter will disengage ("M" indicates starter motor is on).
8. At 42,000 rpm, the gas will be switched off ("G" indicates gas is on).
9. The turbine is self-sustaining and will continue to ramp up to 65,000 rpm.
10. "Idle Adjust" will be displayed and the turbine speed will be reduced to 55,000 rpm.

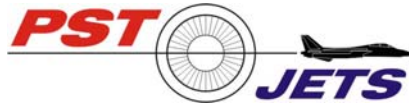

J600R Instruction Manual

PST TEMS (Cont)

11. You can now calibrate the J600R for maximum speed (or desired derated speed) and higher idle speed as described in the Calibrating MIN and MAX rpm section.
12. The turbine can be shutdown by moving the throttle stick to minimum and the trim lever to minimum.
13. After shutdown, the TEMS will cool the turbine by spooling between 2000 and 7000 rpm until the EGT is below 120 C. **“COOLING”** will be displayed during this period. The GDT programming function is inactive during the cooling cycle. Note: You may switch the radio transmitter and receiver off during the cooling period but the TEMS power must be left on. In other words don't switch off the turbine circuit.

You can monitor the start sequence via messages displayed on the GDT. The messages are as followed:

1. **M Glow On** - M=Motor Start ; Glow On=glow plug is powered
2. **G Glow On** - G=Gas open ; Glow On=glow plug is powered
3. **MG Glow On** - Motor and Gas on
4. **Step Fail** - Shutdown step due to faults
5. **MG Ramp** - Turbine is between start and 15,000 rpm
6. **M Ramp** - Turbine is between 15,000 and 30,000 rpm
7. **M Ramp** - Turbine is between 30,000 and 40,000 rpm
8. **Ramp** - Turbine is accelerating with fuel to 65,000 rpm
9. **Idle Set** - TEMS is calibrating idle speed to 55,000 rpm
10. **Idle Set (disappear)** - Turbine is self sustained, control is released to user

J. Calibrating MIN and MAX rpm

This feature is available after the engine is running and needs to be done only once on the first run after installation. To calibrate the Min and Max speed, press UP to access the calibration menus and use ENTER to activate the function. **Safety:** Use ears and eyes protection and always have a good fire extinguisher ready.

- **Adjust Idle Speed** – With throttle stick at minimum position, use UP and DOWN keys to adjust Min speed. Minimum speed is default at 55,000 rpm.
- **Adjust Full Speed** – With throttle stick at maximum position, use UP and DOWN keys to adjust Max speed. Maximum speed is 163,000 rpm. You can use this feature to derate the thrust in case maximum thrust is not required.
- **Auto Set Full Speed** – Use this feature to automatically set the Max or Full speed. With the throttle stick set to about 25% above minimum position, use the UP key to activate the calibration process. The TEMS will increase and calibrate the turbine to a maximum full speed between 155,000 and 163,000 rpm then reduce to the set throttle position once the calibration is completed. This feature calibrates the TEMS to the voltage required by the fuel pump at maximum thrust. It is strongly recommended to use this feature to calibrate full speed at the first run of flying session. 163K can then be set using the Adjust Full Speed feature.

Mounting and Installation

1. Carefully insert the mounting straps under the EGT probe as shown in the pictures.
2. Take care that the EGT probe does not bend out of shape and that the end remains securely inserted into the exhaust nozzle.
3. **Important:** The EGT probe end must be inserted not more than 2mm into the tail cone.
4. Mounting straps must be securely fastened with the supplied lock nuts and bolts.
5. Mount the turbine securely to a test bench or airframe as shown. A bench start is useful for familiarization with the turbine and the PST TEMS.
6. A tail pipe is needed for airframe internal installation. If you are uncertain of what size tail pipe to use on your plane, Please e-mail us for recommended sizes appropriate to your aircraft.

		
<p>Securely mount the turbine</p>	<p>Mounting strap goes under the EGT probe</p>	<p>Tail pipe & Mounting</p>
		
<p>Bench starting</p>	<p>Mounting straps securely fastened</p>	<p>EGT probe inserted not more than 2mm in tail cone</p>

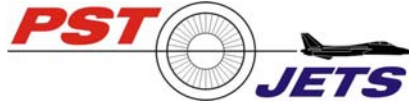

J600R Instruction Manual

Before Start

1. Study the TEMS section thoroughly for start and operation of the auto start feature.
2. TEMS parameters were factory set but your transmitter needs to be calibrated. Please review the TEMS section for setup and calibration of your radio.
3. Check that the system retains the default Ramping Values of 65. We recommend that you start with a value of 65 or higher on your first few starts then reduce this value to not lower than 45 if the startup ramping becomes too slow.
4. From January 1, 2005, AMA requires that all radios used for turbine models must be equipped with fail safe function. The radio and/or ECU shall at a minimum be configured to bring the engine to idle, or preferable to shutdown, within 2 seconds of fail safe activation. Our TEMS can be configured to shutdown the engine within 2 seconds or less after fail safe activation.

Fail Safe Setting: We suggest that the receiver failsafe position is set with a throttle ATV value of 125% - 150% for the minimum throttle position then set to 100% for normal use. For radios that do not have sufficient travel difference between 100% and 150% ATV, the throttle ATV for normal use can be set to 80% low and high with a fail safe position set to 150% (low).

In a fail safe situation (exceeding the set F/Safe Time), this will cause the pulse width to the turbine controller to be smaller than the pulse width for shutdown position which would cause the turbine to shut off immediately. The TEMS will display "R/C Invalid" with a star in the #4 position on the GDT display.

Notes:

1. JR and Futaba throttle reversing is different, please check direction carefully.
2. Turbine models are a big investment; please use good quality radios and servos for your model. If you have any doubts about anything seek expert advice for radio / turbine installations.
3. We recommend that external Rx antennas such as whip antennas are used for good reception and to avoid any interference from the installed electronics and accessories. Another option is to run the antenna outside of the airplane away from carbon composite materials.
4. Avoid installing the receiver close to the fuel pump as the pump motor can produce interference to the radio receiver.
5. It is a good practice (also a GTBA requirement) to use a manual or servo operated fuel shutoff valve as a last resource to shutdown the engine in case of ECU failure. We recommend and have included the 4mm Festo ball valve. Make sure that you have good and quick access to the valve.
6. PST TEMS is simple to use but understanding the setup and operation sequence is critical. Please study this manual carefully.
7. Auto high speed setting is 155,000. If higher rpm is required, users must set the max 163,000 rpm via GDT as discussed earlier.

Starting



Bench start and blower for added safety and extra cooling

Recommendation: We recommend that you start the engine on an outdoor test stand prior to installation into airframe.

Notes: If air bubbles in the fuel line is not removed completely, auto start attempts may not be successful.

Safety: Use eye and ear protection. A fire extinguisher must be in the ready position.

IMPORTANT: Although the TEMS is designed to automate the start-up sequence and to take proper actions for abnormalities, the operator must still be aware of what actions are to be taken in the event of unforeseen problems. The manual fuel shutoff valve must be accessible for immediate manual shutdown and a fire extinguisher must be ready at all times. Servo controlled mechanisms can be installed to control the manual shutoff valve from transmitter if the valve is not easily accessible.

Auto Start Procedure

1. Check that TEMS battery is properly charged to full capacity. **Note:** Limit one full charge to two flights or approximately 25 minutes of running time. Do not use uncharged or low voltage battery packs to run the TEMS as this can cause an in-flight shut down.
2. Make sure the fuel line is properly connected so that the fuel pump will not run dry.
3. Fill the fuel tank. Make sure that manual fuel valve is closed while fueling. Also make sure that your tank has no leaks.
4. When ready for start, open manual fuel and gas shutoff valves, if installed.
5. Make sure that the radio frequency channel is clear. Turn on the Rx and Tx.
6. Connect the GDT and turn on TEMS switch. Observe proper GDT display.
7. Prime engine as described in the TEMS section. Observe proper operation of the fuel solenoid valve.
8. Observe carefully for any fuel line blockage or leak.
9. The fuel line going into engine must be filled for successful auto start.
10. Initiate start sequence thru the GDT (see TEMS section) or thru transmitter. Via transmitter, move throttle trim lever to min then to max. Next, cycle the throttle stick to full thrust then to idle. The start sequence should initiate if the trim and stick movements are done within 5 seconds.
11. Observe the auto start sequence. LED on gas solenoid valve comes on to indicate that the valve is open.
12. "Idle" displays on the GDT indicate that the start is successful.
13. Check that the engine idles at 55,000 rpm and full thrust is set at required rpm. (maximum rpm is 163,000) You can calibrate to 160,000 rpm using the "Auto Set Full Speed" feature as described earlier in the TEMS section. Required max rpm can then be set via "Adjust Full Speed" feature.
14. The turbine is now under your control. Enjoy flying....

Maintenance

1. After each run, make sure that the compressor and turbine wheels spin freely and that there is no sign of any physical defects or unusual noises. The turbine assembly will turn and come to a stop with little braking action confirming that the pre-load on the bearings is still good.
2. Re-cycle the TEMS battery often. Preferably after each flying session or about 10 quick charges.
3. After about 20 starts, check the electric starter O-ring for dirt and clean it as appropriate.
4. To clean the O-ring, the front motor may need to be removed. The starter front case can be removed by turning counter-clockwise. When installing the front case back, care must be taken to ensure that the Bendix is not too close to the spinner nut. The Bendix should be about 0.5mm past the rear case end. As a safeguard, there is a stopper in the rear case to ensure correct positioning.
5. Check that the EGT probe is still in good condition and has no breakage at the point shown in the picture below.
6. If the glow plug needs to be replaced, follow the steps outlined earlier. Make sure that the filament extends out about 2mm. (3/32 of an inch)
7. External filters should be checked and cleaned regularly. Disassemble the filters and clean them as needed. Internal filters (last chance filters) should not need any cleaning if good external filters are used. Avoid opening the front case. Improper removal can cause damage to the turbine thus voiding the warranty.
8. After 120 starts, the turbine needs to be checked and serviced by PST or an authorized service center. Failure to do so will void the warranty.

		
<p>Clutch O-ring</p>	<p>Removing the front motor</p>	<p>Clean O-ring as necessary</p>
		
<p>Front motor assembly</p>	<p>External filters recommended</p>	<p>Handle the EGT probe carefully. Shown is the vulnerable break point</p>

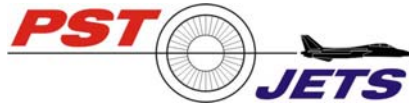

J600R Instruction Manual

J600R Trouble Shooting

<u>Symptoms</u>	<u>Causes & Fixes</u>
1. Engine shut down due to high or low revolution (rpm)	1. <u>TEMS battery may be weak or incorrectly charged.</u> Re-cycle and recharge the battery pack or replace the battery pack. Recalibrate the TEMS again thru "Learn R/C Parameter" feature. 2. <u>Sticky fuel pump.</u> Pump may need to be run-in more. Remove the fuel pump and run fuel thru the pump continuously for about 15 minutes.
2. No gas light up during start	1. <u>Gas canister is empty.</u> Fill the canister. 2. <u>Gas canister may have vapor lock,</u> empty and refill. 3. <u>Gas solenoid valve is not connected properly, or installed gas shutoff valve is closed.</u> Check and open valve. 4. <u>Solenoid valve locked closed due to high pressure gas.</u> Avoid pure propane. Use a maximum of 70/30 propane/butane gas. 5. <u>Glow plug is bad (GDT will indicate this).</u> Replace glow plug. 6. <u>Glow plug voltage is too low.</u> Increase plug voltage thru GDT (as high as 280 may be required) 7. <u>Low battery capacity.</u> Recharge TEMS battery.
3. Engine does not accelerate to maximum set rpm	1. <u>Insufficient fuel or air bubble is entering the engine during initial start.</u> Prime the engine so the fuel line is filled and no air bubbles are present. 2. <u>Low battery capacity.</u> Recharge TEMS battery. 3. <u>EGT Probe is not installed properly.</u> Check that the probe is inserted 2mm into the tail cone.
4. Engine flameout during rolls and inverted maneuvers	1. <u>Air bubbles in the fuel system.</u> Check fuel line and tank installation and make sure that no air bubbles are present in the header tank. Use bubble-elimination devices for bubble free fuel.
5. EGT is too high (above 760 C)	1. <u>EGT probe is not inserted correctly.</u> Make sure that the EGT probe end is not more than 2mm into the tail cone.

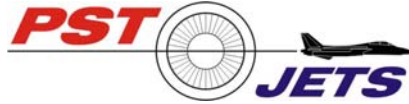

J600R Instruction Manual

J600R Trouble Shooting (cont)

<u>Symptoms</u>	<u>Causes</u> & Fixes
6. Electric starter not turning	1. <u>Loose wiring or connection to TEMS.</u> Check motor start wiring and connections. 2. <u>E-starter is bad or motor life exceeds expected 200 starts cycle.</u> Contact us for replacement starter motor. 3. <u>Motor needs cleaning.</u> Clean as described earlier in this manual
7. Strong vibration and unusual noises	1. <u>Foreign materials may have entered the turbine and damaged the compressor wheels. Dirt or small particles may have entered the engine bearing tube, causing damage to the bearings.</u> The engine must be sent to PST Jets or an authorized service center for inspection and repair.
8. Flame shooting out during start (Hot Start)	1. <u>Excessive fuel in the engine or liquid propane is entering the turbine.</u> Blow excess fuel out of the turbine or initiate start sequence with the gas and fuel valves closed. Clean and wipe off excess fuel from the exhaust area and tail pipe before the next start attempt. Make sure that the gas canister is standing upright. 2. <u>Start Up Ramp is too quick.</u> Increase start up ramp to a value higher than 65.

** More trouble shooting can be found in the TEMS & FAQ section **

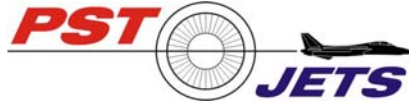

J600R Instruction Manual

J600R Specifications

PST reserves the right to make periodic upgrade and improvements to the J600R and all components related thereto without notice.

Dimensions: Outer diameter: 89mm; Length: 168mm (238mm with starter)

Weight: J600 - 900 grams (1000 grams with motor start)
J600R – 1000 grams (1100 grams with motor start)

Output: J600 - Maximum thrust 5.5 kg @ 160,000 rpm
J600R – maximum thrust 6.5 kg @ 163,000 rpm
(Recommend 155K-163K rpm for normal operation); Idle thrust 0.2 kg at 55,000 rpm *

Diffuser: 7075 Aluminum

Combustion chamber: Inconel + 316 Stainless steel and Inconel vaporizing tubes

Bearings: GRW Ceramic angular contact cageless bearing

Shaft: EN 24 grade steel

NGV: PST Vacuum cast stainless steel

Turbine: PST Vacuum cast Inconel 713
Certified/X-rayed to AMS-STD-2175 Grade B Aerospace Standard

Compressor: Garrett, High-grade aluminum alloy

Motor Start: Aluminum casing, copper clutch assembly, ball-bearing 280 motor

Technology: CAD/CAM & CNC Milling and Lathe; Digital & Infrared balancing

Other components: High-grade stainless steel

Accessories: Anodized stainless steel front casing & engine mounts, high grade gas/fuel tubing & filters, silicon electrical wiring with gold plated connectors

* Based on 30C (86F) outside air temp; 1013 HPa Barometric pressure; Sea level

Diagram A: Fuel & Gas Canister/Cartridge Setup

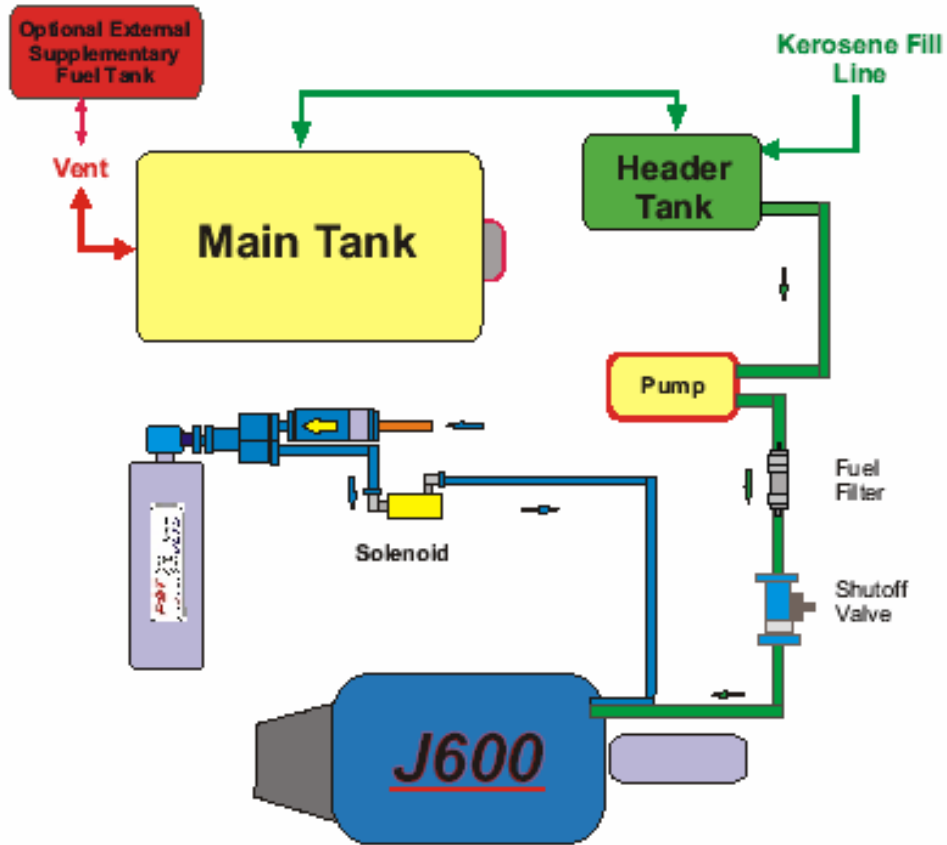

Diagram B: Internal Gas Canister/Cartridge Setup

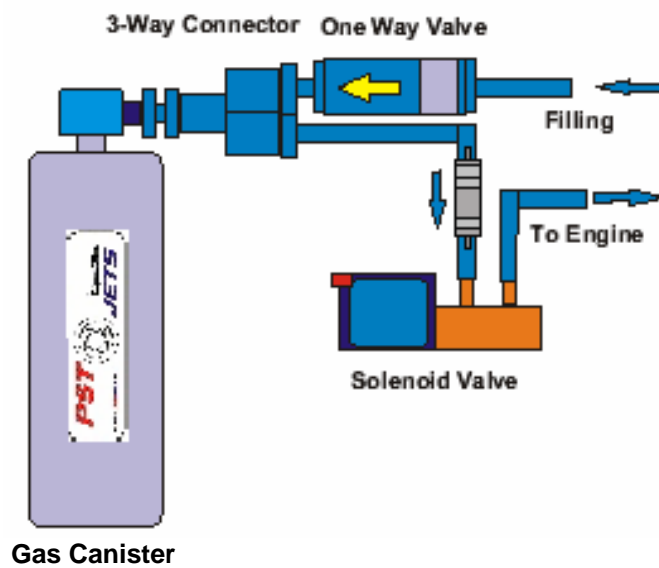
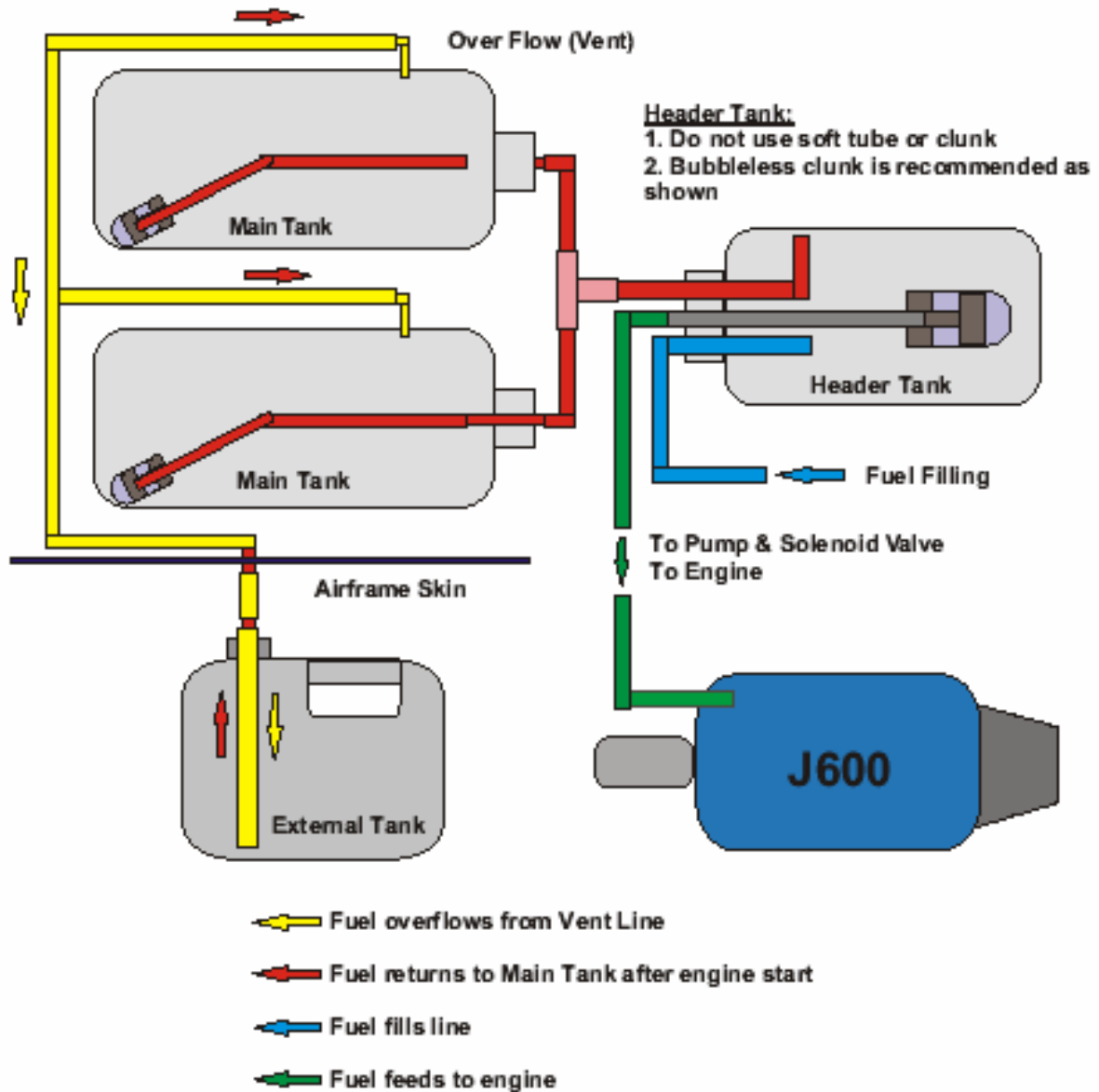
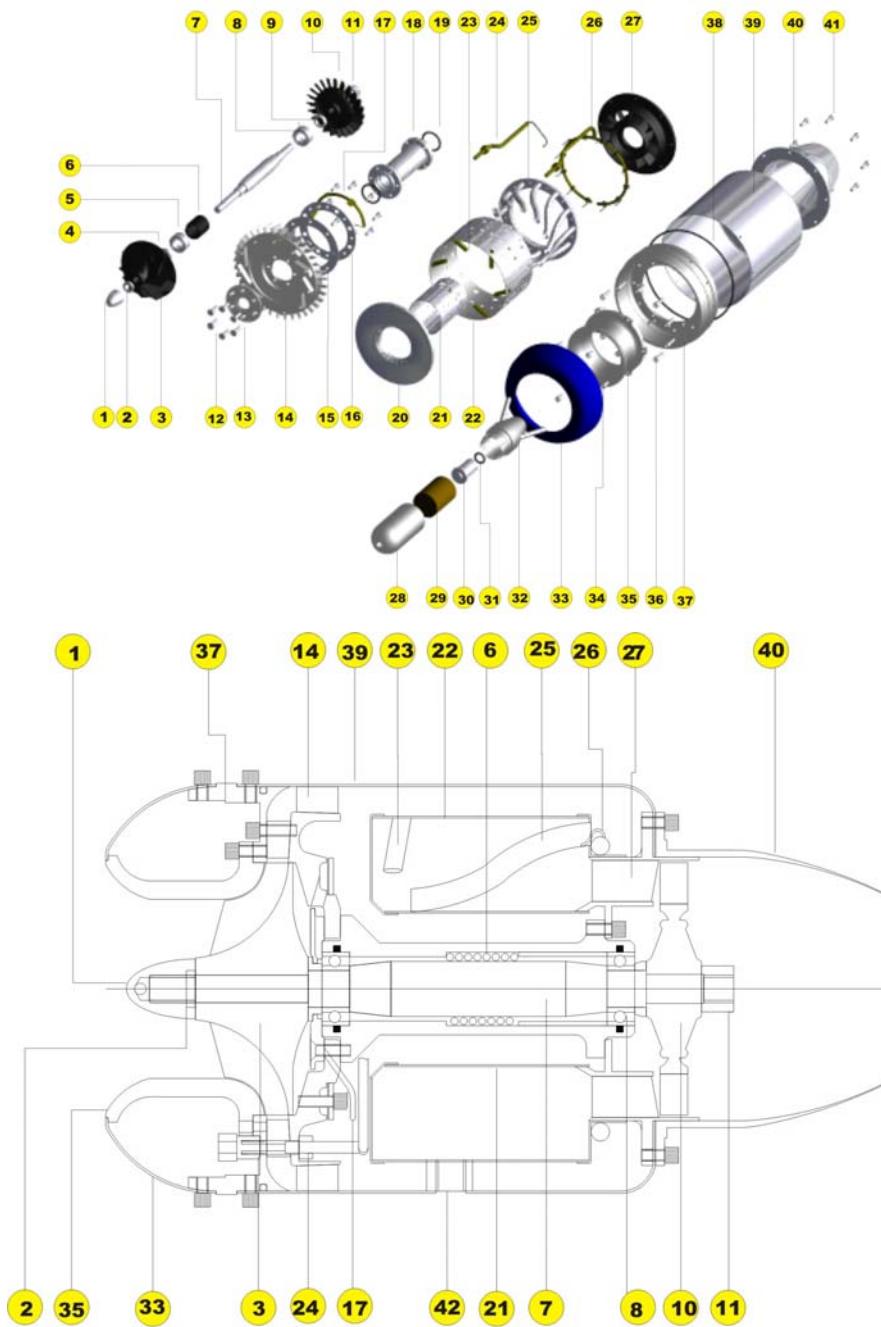
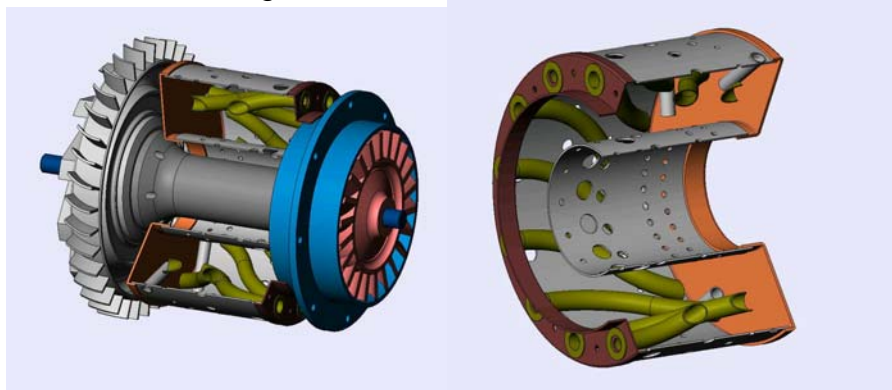

Diagram C: Main & Header Tank Setup



J600R Instruction Manual

Diagram D: J600R Sectional View



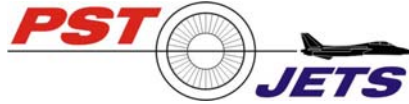

J600R Instruction Manual

J600/R Parts list

Item #	Description	Item #	Description
1	Spinner Nut	21	Combuster Inner
2	Magnet Ring	22	Combuster Outer
3	Compressor Wheel	23	Swirl Jets
4	Front Spacer	24	Gas Line
5	Front Bearing	25	Vaporizer/Combuster Rear
6	Preload Spring	26	Fuel Injectors
7	Rotor Shaft	27	NGV (Nozzle Guide Vane)
8	Rear Bearing	28	Starter Case Front
9	Rear Spacer	29	Electric Motor
10	Turbine Wheel	30	Clutch
11	Turbine Nut	31	Clutch O-ring
12	Bolts	32	Starter Case Rear
13	Shaft Seal	33	Engine Front Cover
14	Diffuser	34	Bolts
15	Filter Mesh	35	Bell mount Intake
16	Filter Cover	36	Bolts
17	Lubrication Line	37	Diffuser Cover
18	Bearing Tube	38	Case O-ring
19	O-ring	39	Case Outer
20	Combuster Front	40	Exhaust Cone
		41	Bolts
Not Shown	J600R Tail cone	42	Glow Plug Mount

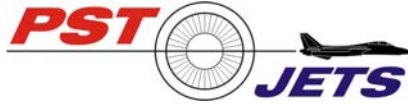

J600R Instruction Manual

FAQ/Info

What's new with V2.38 TEMS? New "Glitch Counter" and "Adjust Fail Safe Time" are added. Circuit boards with a new processing unit and program is upgraded to protect the TEMS against program corruption during start with a weak battery. The new TEMS is very stable and proved to be very effective with our J600/R turbine. Program V2.37 has the same ramping values as V2.33/V2.34/V2.36. Please note that the V2.37 program is not compatible with V2.34 or V2.33 due to different processing units, therefore, it is not possible to upgrade V2.34 or V2.33 to V2.37 software without having to change the circuit boards. (Nov 2004) New Fuel solenoid feature is also incorporated into this new V2.38 TEMS.

New improved GDT with V2.38 TEMS GDT is modified to prevent the engine from shut-down when connecting the GDT to the TEMS after start or while engine is running. You can now connect or disconnect GDT at any phases of operation. (Nov 2004)

I get "Hung" start This can happen at around 30-35k rpm especially with the engine mounted with the glow plug inverted at 6 O'clock position. The main cause is the starting gas pressure being too high. Lower the gas pressure will solve this Hung start problem. (Nov 2004)

I use kerosene from a hardware store. What precautions should I take ? Please make sure that the kerosene is free from moisture and use a good filter when transferring to your filling tank. Kerosene itself is clean and can be used with model turbine engines. It is the method of storing that requires special attention. Some hardware stores don't store the kerosene properly thus allowing moisture and dirt to enter the container. (Nov 2004)

What's new with V2.34 TEMS? Auto high speed setting is lowered to 155,000 instead of the older 160,000. This prevents the possibility of over speed during full speed calibration at high altitudes. Users must set the max 160,000 rpm via GDT. (Sept 2003) Please note that J600R will continue to use V2.33 due to higher ramping requirement.

The engine will not rev up to 160k with the auto high speed set You have a blockage or bends in the fuel system. Check that the fuel tank, fuel line and filters are free from obstruction. **Important:** After clearing the fuel line and filters, **recalibrate your radio Tx and start the engine normally but do not increase the rpm to maximum yet.** Slowly increase the throttle to 1/4 and observe any abnormal rev-up response. Previous pump calibration with fuel line blockage has been memorized as an incorrect entry and too much voltage for the fuel pump will occur. Adjust the rpm to around 100,000 and do the auto high speed setting. Your system should now operate normally. (July 2003)

My engine shuts down when I plug in the GDT (V2.34 and earlier). Due to specific power supply circuitry in the TEMS unit, plugging in the GDT while the engine is running may cause a significant power change that resembles power failure/low voltage conditions. Please connect the GDT prior to start and avoid connecting the GDT while the engine is running. Shutdown is however, harmless to the engine and shutdown/cool down sequences will continue to function normally. (June 2003)

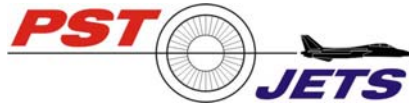

J600R Instruction Manual

FAQ/Info (Cont)

I cannot calibrate the maximum thrust accurately to 160,000 rpm with the automatic function. Raise the throttle to about 1/4 to 1/2 before initiating the calibration. (June 2003)

I cannot start from my Tx Make sure that sequencing of the throttle trim and stick lever is within 5 seconds. Follow the sequence outlined in this manual. (May 2003)

Which turbine oil should I use? You can use Shell 500, Exxon 2380, 2197, Mobil II and other high grade turbine oil. (2002)

How can I mix the fuel to get 5% mixture? The easiest way is to mix 20 liters of fuel. Put in one liter of turbine oil and 19 liters of kerosene. This will give you a 5% oil mix. The J600 will tolerate mixture imperfections between 4-6%. (2002)

What glow plug and voltage setting do I use? A3 is the cheapest OS glow plug and it is very good. Glow plug voltage setting via the GDT is default at 180 (1.8V) and should be sufficient for the A3 plug. However, if you are experiencing difficulty in lighting up, try to increase the voltage at small increments of 5 up to 230. For stronger (colder) plugs, the voltage can be as high as 240-260. (2002)

I get some erratic rpm readings during start, what should I do? We have tested to ensure that the wiring bundle has no effect on the J600 operation but due in special cases and installations, some interference in the wiring bundle has been reported. Try to separate the rpm sensor wiring from the electric starter leads. Separating the radio receiver battery and ECU battery is also a good idea even though we have not experienced interference with battery location issues in our jets. (2002)

I fly in a dirty/polluted or dusty environment and have a high risk of FOD, what can I do? Installation of a protective screen to protect the turbine from foreign objects is recommended. Email us for installation tips. (2002)

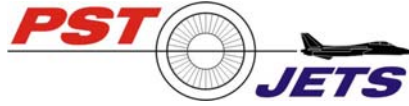

J600R Instruction Manual

J600R Log

Owner: _____ Serial Number: _____ Purchase Date: _____
TEMS Serial Number: _____

Menu	Function	Default	J600R
Ramping Values	Adjust Ramp Sw Lo	15	
	Adjust Ramp Sw Hi	80	
	Adjust Ramp Up Lo	12	
	Adjust Ramp Down Lo	8	
	Adjust Ramp Up Mid	4	
	Adjust Ramp Down Mid	4	
	Adjust Ramp Up Hi	4	
	Adjust Ramp Down Hi	4	
Physical Adjusts	Adjust Glow Driver	240	
	Adjust Start Ramp	65	
	Adjust Idle Rev	55	
	Adjust Max Rev	163	

Start No.	Date	Model	Place	Engine Time	Flight Time	Remarks / Notes

